



凯朗 浙江凯朗锁业有限公司
Zhejiangkailanglock CO., Ltd

平面锁系列

Flat lock series

KL-31173

技术参数 Technical Parameter

- ✓ 材质: 锌合金锁体、转轴、镀锌压板、锁片、螺杆
- ✓ 表面处理: 镀亮铬/渡沙铬/喷塑黑
- ✓ 结构说明: 挑起手柄旋转90° 实现或关闭
- ✓ 防水等级: IP65



基本尺寸 Basic dimensions					产品型号 PRODUCT
L1	L2	L3	B1	B2	KL-31173
172	140	70	42	29	

产品尺寸图 Product size

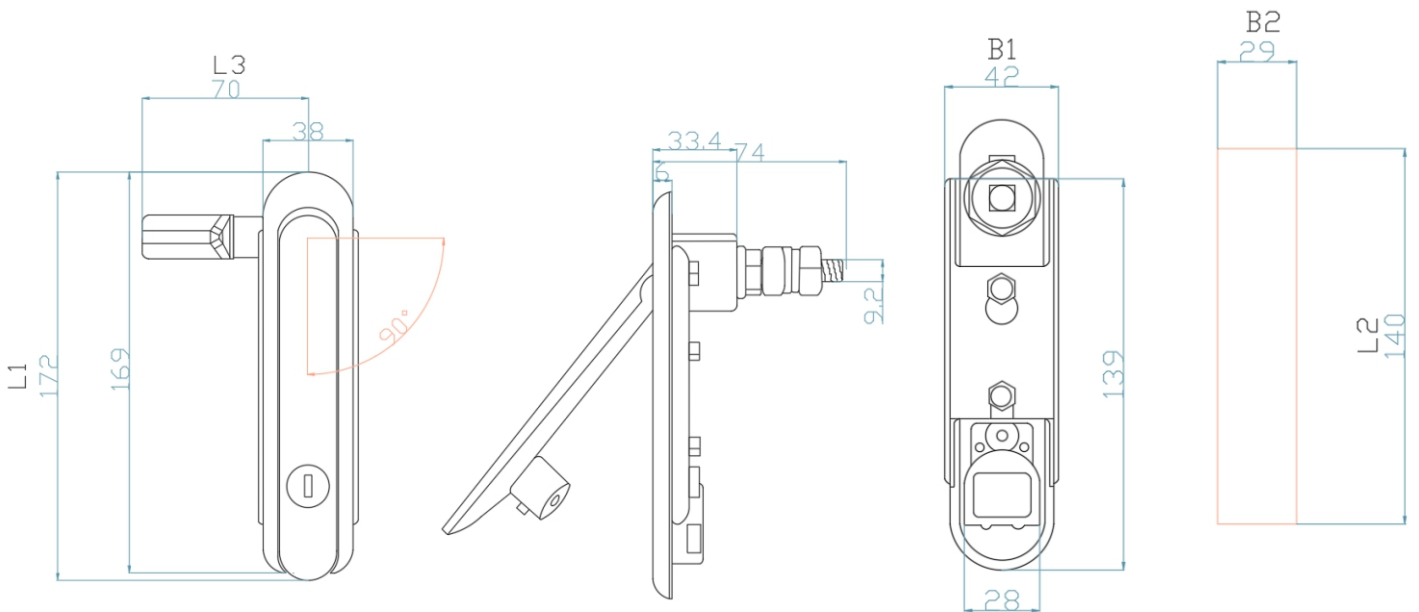

Communicate with you and me for a win-win future



+8615606777659

52712012@qq.com

浙江省温州市乐清市柳市镇岐头一村岐富路85号
No. 85, Qifu Road, Qitou First Village,
Yueqing City, Wenzhou City, Zhejiang Province

+86057762250322

https://kailangsuoye.1688.com